

AWP 515

“Analog or CANopen Output,
High Accuracy”



- Measuring length up to 15000 mm
- Magnetic absolute measurement technology
- Robust stainless steel measuring wire
- Aluminium housing
- Analog or CANopen output
- Programmable analog output option
- IP54 protection class (Optional IP67)
- Compact design and easy mounting
- 1 m/s maximum movement speed
- Shock/vibration resistant

MECHANICAL DATA

Measuring Range (stroke)	Up to 15000 mm
Max. Movement speed	1 m/s
Extension Force	12N
Protection Class	IP54 (Optional IP67)
Operating Temperature	-40°C...+85°C
Material	Body: Aluminium
	Measuring wire: Stainless steel

MECHANICAL DIMENSIONS (mm)

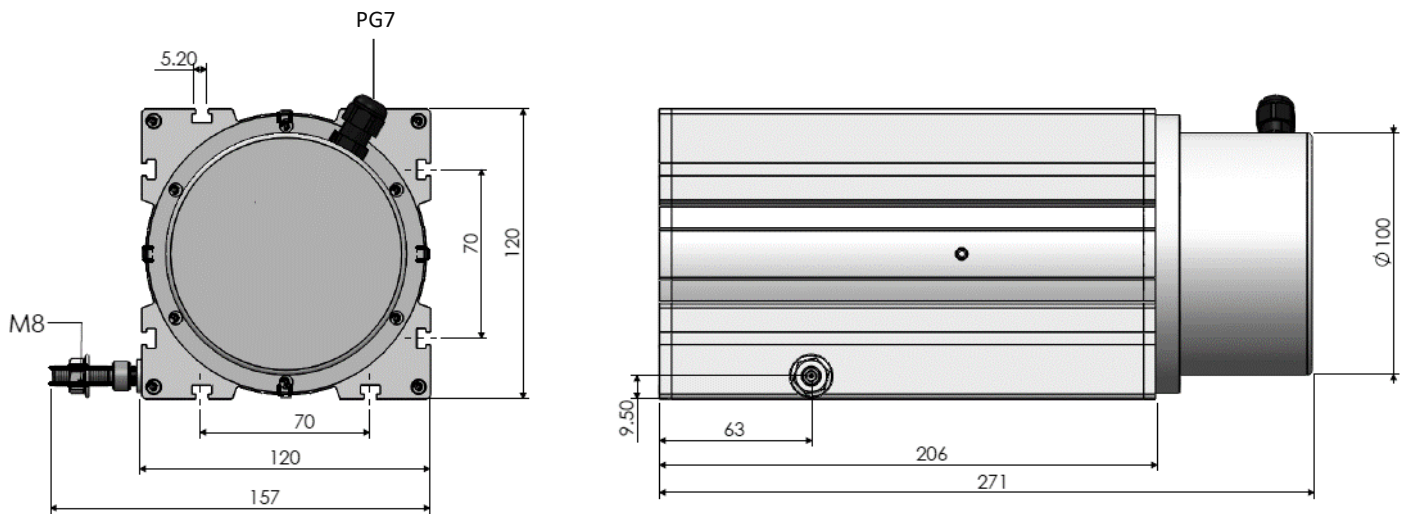

MOUNTING AND WARNINGS

1. Never release the wire after pulling. Otherwise, the coil spring will be damaged.

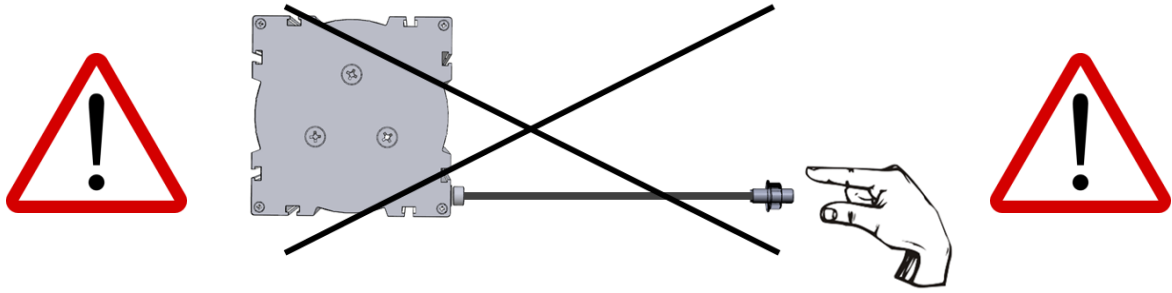

2. Mount the sensor according to the mounting directions shown below.

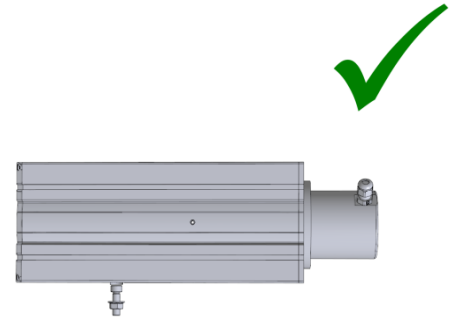
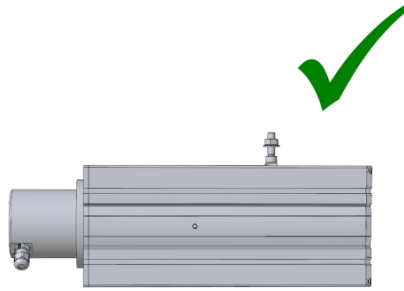
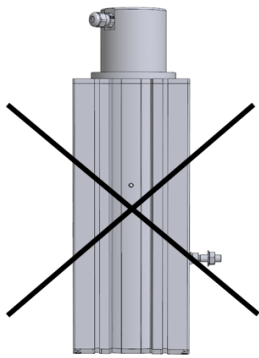

3. If there is a trickle of water (like a rain), the wire outlet must not be a drip of water upstream. If needed please use guide rollers.

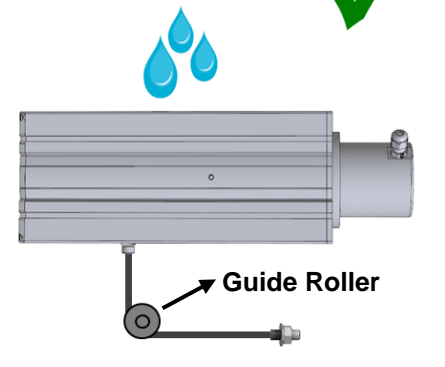
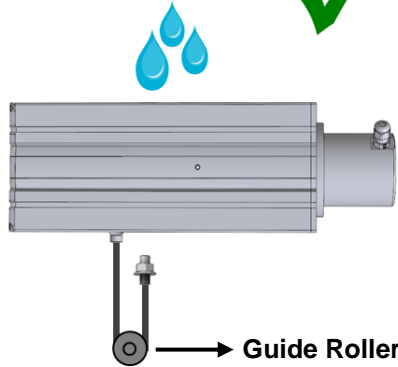
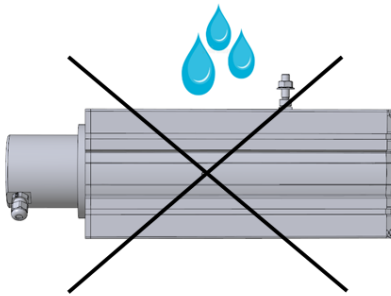

4. The wire should not be pulled in angular. If needed, please use guide rollers.

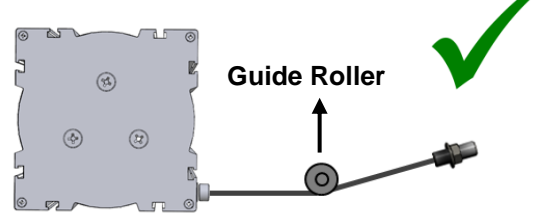
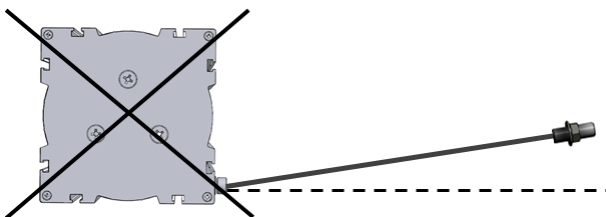

Important Note(!): Failure to comply with these recommendations, the malfunctions that may occur will not be under the warranty.

ANALOG VERSION

Electrical Specifications

Measuring range	Up to 15000 mm
Supply voltage	15...26 VDC
Current consumption	≤60 mA
Reverse polarity protection	Yes
Short circuit protection	Yes (only supply)
Response frequency	500 Hz
Resolution	0.05 mm
Linearity	±%0.5 FS
Output signal	Voltage: 0-10V, 0.5-4.5V, 0-5V Current: 4-20 mA
Signal characteristics	Increasing (exmp: 4-20 mA) Decreasing (exmp:20-4 mA)
Sensing device	Magnetic absolute encoder
Electrical connection	M12 connector or cable

Electrical Connection

Signal	Cable	M12 / 5 pin male connector
V+ (15...26 VDC)	Red	Pin 1
Analog output signal	Yellow	Pin 2
GND	Black	Pin 3
N/C	Green	Pin 4
N/C	Pink	Pin 5

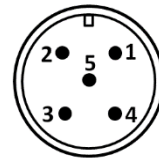

Order Code

Model		Electrical Connection			Protection Class			
		S13M: M12/5 pin male connector 2M: 2m cable *Optional others			No code : IP54 (std) IP67 : IP67			
AWP 515	-	XXXX	-	XXXX	-	XX	-	XXXX
Measuring Range Up to 15000 mm				Analog Output Signal V : 0-10 VDC V1 : 0-5 VDC A : 4-20 mA V3 : 0.5-4.5 VDC NV : 10-0 VDC NV1 : 5-0 VDC NA : 20-4 mA NV3 : 4.5-0.5 VDC				

ANALOG VERSION, PROGRAMMABLE

Electrical Specifications

Measuring range	Up to 15000 mm
Supply voltage	15...26 VDC
Current consumption	≤60 mA
Reverse polarity protection	Yes
Short circuit protection	Yes (only supply)
Response frequency	500 Hz
Resolution	0.05 mm
Linearity	±%0.5 FS
Output signal	Voltage: 0-10V, 0.5-4.5V, 0-5V (programmable) Current: 4-20 mA (programmable)
Signal characteristics	Increasing (exmp: 4-20 mA) Decreasing (exmp:20-4 mA)
Sensing device	Magnetic absolute encoder
Electrical connection	M12 connector or cable

Electrical Connection

Signal	Cable	M12 / 5 pin male connector
V+ (15...26 VDC)	Red	Pin 1
Analog output signal	Yellow	Pin 2
GND	Black	Pin 3
N/C	Green	Pin 4
SPAN/ZERO	Pink	Pin 5

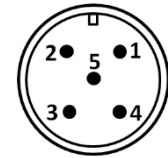

SETTING MEASUREMENT LIMITS: With this feature, you can set the minimum and maximum measurement limits.

In order to determine the **minimum measurement limit (lim1)**, the SPAN/ZERO and GND terminal are short-circuited for at least 3 seconds.

In order to determine the **maximum measurement limit (lim2)**, the SPAN/ZERO and GND terminal are short-circuited for at least 6 seconds.

To **return to the factory settings**, the SPAN/ZERO and GND terminal are short-circuited for at least 10 seconds.

SAMPLE SIGNAL OUTPUT GRAPHICS

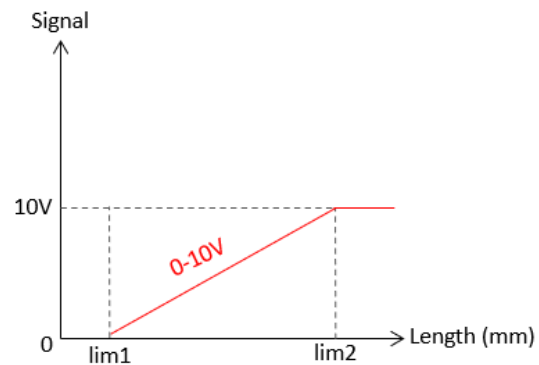
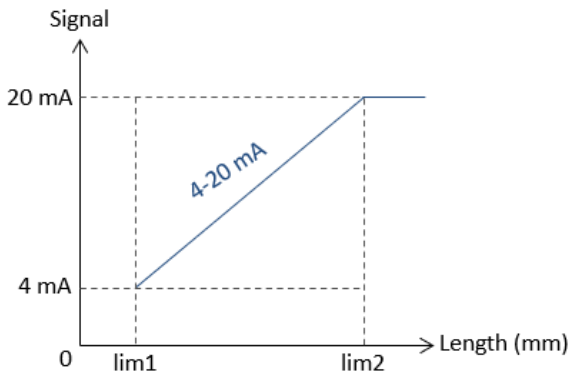

Order Code

Model		Electrical Connection			Programming Feature		
AWP 515		S13M: M12/5 pin male connector 2M: 2m cable *Optional others			PL: Programmable		
XXXX	XXXX	XX	XX	XXXX			
Measuring Range		Analog Output Signal			Protection Class		
Up to 15000 mm		V : 0-10 VDC V1 : 0-5 VDC A : 4-20 mA V3 : 0.5-4.5 VDC NV : 10-0 VDC NV1 : 5-0 VDC NA : 20-4 mA NV3 : 4.5-0.5 VDC			No code : IP54 (std) IP67 : IP67		

CANopen VERSION

Electrical Specifications

Measuring range	Up to 15000 mm
Supply voltage	12...30 VDC
Current consumption	≤60 mA
Reverse polarity protection	Yes
Short circuit protection	Yes (only supply)
Response frequency	500 Hz
Resolution	20 µm
Linearity	±%0.5 FS
Sensing device	Magnetic absolute encoder
Electrical connection	M12 connector or cable

CANopen Specifications

Communication Profile	CiA 301
Device Type	CANopen, CiA DS406
Node ID	Adjustable from 1 to 127 with LSS or SDO
Baud Rate	10 kBit/s, 20 kBit/s, 50 kBit/s, 100 kBit/s, 125 kBit/s, 250 kBit/s, 500 kBit/s, 800 kBit/s, 1 Mbit/s
PDO Data Rate	100 ms
Error Control	Heartbeat, Emergency Message
PDO	3 Tx PDO
PDO Modes	Event/Time triggered, Synch/Asynch
SDO	1 server
Position Information	Object Dictionary 0x6020
Termination Resistance	Optional 120Ω

Electrical Connection

Signal	Cable	M12 / 5 pin male connector
CAN SHIELD	CAN SHIELD	Pin 1
V+ (12...30VDC)	Red	Pin 2
GND	Black	Pin 3
CAN_H	Yellow	Pin 4
CAN_L	Green	Pin 5

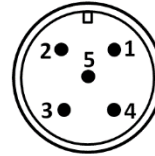

Order Code

Model	Electrical Connection	Protection Class
AWP 515 - XXXX - XXXX - X - XXXX	S13M: M12/5 pin male connector 2M: 2m cable *Optional others	No code : IP54 (std) IP67 : IP67
	Measuring Range Up to 15000 mm	Output Signal C : CANopen